



Spraying Systems Co.[®]
Experts in Spray Technology



Spray
Nozzles



Spray
Control



Spray
Analysis



Spray
Fabrication



Liquid Strainers

Protect nozzles, valves and pumps
from damaging debris.

T Strainers

Low to Medium Pressure

TW.....	3
TWC.....	3
TWF.....	4
16106.....	4
9830.....	5
122-PP.....	5
122-NYC.....	5
124-I.....	6
124-AL.....	6
124-ML-AL.....	6
124A-SC-NYB.....	6
430-ML.....	6

High Pressure

15925.....	7
8310A.....	7
2820.....	8

Specialty Filters

39185.....	9
------------	---

Accessories

Pressure Gauges

26383.....	10
26385.....	10

Gauge Snubber

39194.....	10
------------	----

Technical Data

Screen Cleaning

and Replacement.....	11
----------------------	----

Pressure Drop Calculations.....

.....	12
-------	----

Basket and Screen Data.....

.....	13
-------	----

Ordering Information

Ordering information is included for all of the product listings within the catalog. For most products, you will need to know the inlet connection size, connection type, material required and mesh size.

Sample Ordering Information

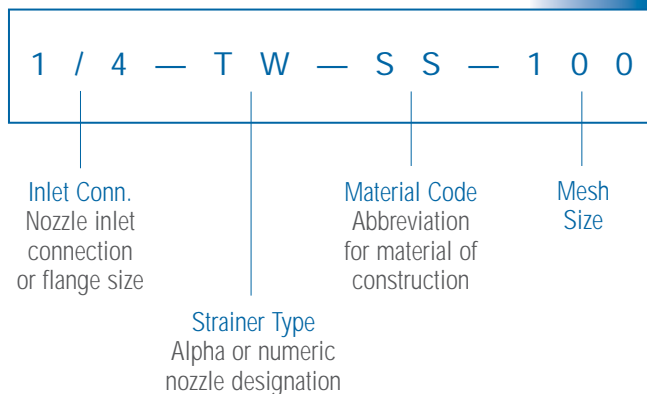

Material Codes

Material	Material Code
Aluminum	AL
Brass	B
Bronze	BR
Cast Iron	None
Ductile Iron	None
Nylon	NYB
Clear Nylon	NYC
Polypropylene	PP
Stainless Steel	SS
Clear Styrene Acrylonitrile	SAN

Model TW



Features and Benefits

- Large open screen area for efficient liquid straining
- Designed for minimal maintenance
- Removable bottom cap or plug for complete withdrawal of entire screen assembly
- Bottom pipe plug can be replaced with a drain cock for quick-flush cleaning

Specifications

Inlet Connection	Materials	Connection Type NPT or BSPT (F)	Pressure Rating	Available Mesh
1/4", 3/8", 1/2", 3/4", 1", 1-1/4", 1-1/2", 2", 2-1/2"	Cast Iron, Aluminum, Brass, Stainless Steel	Threaded	125 psi @ 150° F (9 bar @ 66° C)	16, 30, 50, 80,100, 40 x 200 Dutch Weave

Dimensions and Weights

- Contact your Spraying Systems Co. sales engineer for dimensions and weights

Ordering Information

1 / 4 — T W — S S — 1 0 0

| | | | |

Inlet Conn. Strainer Type Material Code Mesh Size

See pages 13 for additional mesh data and ordering information.

Model TWC



Features and Benefits

- Large open screen area for efficient liquid straining
- Designed for minimal maintenance
- Designed to handle large flow rates with minimal pressure drop
- 1" plugged top outlet is provided for pressure gauge installation
- Bottom pipe plug can be replaced with a drain cock for quick-flush cleaning

Specifications

Inlet Connection	Materials	Connection Type NPT or BSPT (F)	Pressure Rating	Available Mesh
2-1/2", 3", 4"	Cast Iron	Threaded	125 psi @ 150° F (9 bar @ 66° C)	50 x 40, 80 x 70, 16P Perf. screen

Dimensions and Weights

- Contact your Spraying Systems Co. sales engineer for dimensions and weights

Ordering Information

3 — T W C — 5 0

| | | |

Inlet Conn. Strainer Type Mesh Size

See pages 13 for additional mesh data and ordering information.

Model TWF

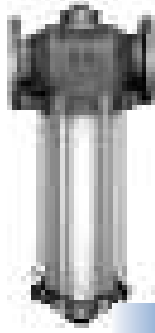

Features and Benefits

- Designed to handle extra large flow rates with minimal pressure drop
- Flange mounting hole sizes and locations meet American Standard 125 specifications
- 1" plugged top outlet is provided for pressure gauge installation on some sizes

Specifications

Inlet Connection	Materials	Connection Type	Pressure Rating	Available Mesh
3", 4", 6"	Cast Iron, Ductile Iron	Flanged	125 psi @ 150° F (9 bar @ 66° C)	50 x 40, 80 x 70, 16P perf. screen

Dimensions and Weights

- Contact your Spraying Systems Co. sales engineer for dimensions and weights

Ordering Information

3	—	T W	F	—	1 6 P
Inlet Conn.		Strainer Type	Flange Conn.		Mesh Size

See pages 13 for additional mesh data and ordering information.

Model 16106

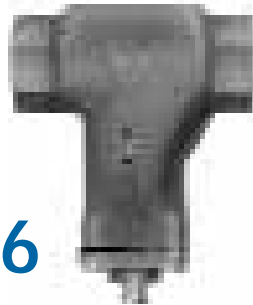

Features and Benefits

- Operates at pressures up to 200 psi (14 bar)

Specifications

Inlet Connection	Materials	Connection Type NPT or BSPT (F)	Pressure Rating	Available Mesh
1-1/2", 2", 2-1/2"	Brass, Stainless Steel	Threaded	200 psi @ 150° F (14 bar @ 66° C)	16, 50, 80, 100

Dimensions and Weights

- Contact your Spraying Systems Co. sales engineer for dimensions and weights

Ordering Information

1 6 1 0 6	—	2	—	T W	—	B	—	1 0 0
Strainer Prefix No.		Inlet Conn.		Strainer Type		Material Code		Mesh Size

See pages 13 for additional mesh data and ordering information.

Model 9830

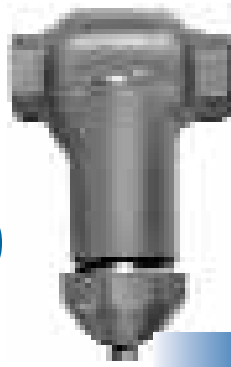

Features and Benefits

- Operates at pressures up to 300 psi (21 bar)
- Ribbed cap with gasket seal can be easily removed by hand for screen access

Dimensions and Weights

- Contact your Spraying Systems Co. sales engineer for dimensions and weights

Ordering Information

9 8 3 0 — 1 — T W — 5 0

Strainer Prefix No. Inlet Conn. Strainer Type Mesh Size

See pages 13 for additional mesh data and ordering information.

Specifications

Inlet Connection	Materials	Connection Type NPT or BSPT (F)	Pressure Rating	Available Mesh
3/4", 1"	Ductile Iron	Threaded	300 psi @ 150° F (21 bar @ 66° C)	16, 50, 100

122



122-NYC model has a clear nylon bowl for easy visual inspection of the internal screen



122-PP

Features and Benefits

- Ideal for low volume applications at medium pressures
- Hand-removable guide bowl for easy maintenance
- Polypropylene bowl and head are corrosion and chemical resistant

Dimensions and Weights

- Contact your Spraying Systems Co. sales engineer for dimensions and weights

Ordering Information

A A 1 2 2 — 1 / 2 — P P — 5 0

Strainer Type Inlet Conn. Material Code Mesh Size

See pages 13 for additional mesh data and ordering information.

Specifications

Model	Inlet Connection	Materials	Connection Type NPT or BSPT (F)	Pressure Rating	Available Mesh
122-PP	1/2", 3/4"	Polypropylene	Threaded	150 psi @ 100° F (10 bar @ 38° C)	16, 30, 50, 80, 100, 200, 40 x 200 Dutch Weave
122-NYC	1/2", 3/4"	Polypropylene head, clear nylon bowl	Threaded	150 psi @ 100° F (10 bar @ 38° C)	16, 30, 50, 80, 100, 200, 40 x 200 Dutch Weave



124



124-I

Features and Benefits

- Ideal for maximum flow rates
- Extra large stainless steel screens require less frequent cleaning and maintenance
- A self-cleaning model and a variety of materials are available

Ordering Information

AA124	—	3/4	—	SC	—	NYB	—	50
Strainer Type		Inlet Conn.		Self Cleaning		Head Material Code		Mesh Size

See pages 13 for additional mesh data and ordering information.

124A-SC-NYB

is a self-cleaning design that allows the filtered liquid to pass through the strainer while liquid particles are returned to the liquid supply







430-ML & 430-SC

features holes for mounting to machinery or an angle iron

Dimensions and Weights

- Contact your Spraying Systems Co. sales engineer for dimensions and weights

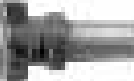
Specifications

Model	Inlet Conn.	Material	Conn. Type NPT or BSPT (F)	Pressure Rating	Available Mesh
 124-I	3/4", 1", 1-1/4", 1-1/2", 2", 2-1/2"	Cast iron head, nylon bowl	Threaded	150 psi @ 100° F (10 bar @ 38° C)	16, 30, 50, 80
 124-AL	3/4", 1", 1-1/4", 1-1/2", 2", 2-1/2"	Aluminum head, nylon bowl	Threaded	150 psi @ 100° F (10 bar @ 38° C)	16, 30, 50, 80
 124ML-AL	3/4", 1", 1-1/4", 1-1/2", 2", 2-1/2"	Aluminum head, nylon bowl	Threaded	150 psi @ 100° F (10 bar @ 38° C)	16, 30, 50, 80
 124A-SC-NYB	3/4", 1", 1-1/4", 1-1/2"	Head available in cast iron, aluminum. Nylon bowl only	Threaded	110 psi @ 100° F (8 bar @ 38° C)	16, 30, 50, 80
 430-ML & 430-SC	3/4", 1", 1-1/4", 1-1/2"	Polypropylene head and bowl	Threaded	110 psi @ 100° F (8 bar @ 38° C) 75 psi @ 100° F (5 bar @ 38° C)	16, 30, 50, 80 120 (only for 1-1/4", 1-1/2" inlet sizes) 200 (only for 3/4", 1" inlet sizes)

15925

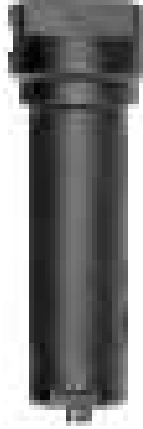

Features and Benefits

- Removable bottom pipe plug provides an easy method for flush cleaning

Dimensions and Weights

- Contact your Spraying Systems Co. sales engineer for dimensions and weights

Ordering Information

1 5 9 2 5 — 3 / 4
 | |
 Strainer Type Inlet Conn.

See pages 13 for additional mesh data and ordering information.

Specifications

Inlet Connection	Materials	Connection Type NPT or BSPT (F)	Pressure Rating	Available Mesh
3/4", 1"	Black oxide-coated mild steel body	Threaded	2000 psi @ 150° F (138 bar @ 66° C)	50

8310A

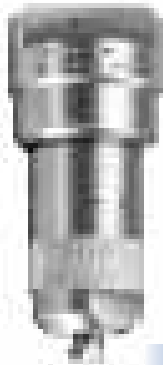

Features and Benefits

- Removable bottom pipe plug provides an easy method for flush cleaning

Dimensions and Weights

- Contact your Spraying Systems Co. sales engineer for dimensions and weights

Ordering Information

8 3 1 0 A — 1 / 4 — 5 0
 | | |
 Strainer Type Inlet Conn. Mesh Size

See pages 13 for additional mesh data and ordering information.

Specifications

Inlet Connection	Materials	Connection Type NPT or BSPT (F)	Pressure Rating	Available Mesh
1/4", 3/8", 1/2"	Stainless Steel	Threaded	5000 psi @ 150° F (345 bar @ 66° C)	16, 30, 50, 100

2820

Features and Benefits

- In-line strainer comes with a choice of stainless steel or MONEL® screens in a variety of mesh sizes

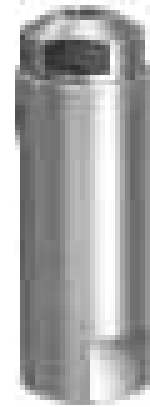

Dimensions and Weights

- Contact your Spraying Systems Co. sales engineer for dimensions and weights

Ordering Information

2 8 2 0	—	1 / 4	—	S S	—	1 6
 Strainer Type		 Inlet Conn.		 Material Code		 Mesh Size

See pages 13 for additional mesh data and ordering information.

Specifications

Inlet Connection	Outlet Connection	Materials	Connection Type NPT or BSPT (F)	Pressure Rating	Available Mesh
1/4", 3/8", 1/2"	1/4"	Stainless Steel Body	Threaded	5000 psi @ 150° F (345 bar @ 66° C)	16, 30, 50, 100

Model 39185

Features and Benefits

- Removes grit, scale and organic solids to help keep spray nozzles clean and clog free
- Removes slimy solids and algae from process water without premature loading
- Extra solids holding capacity provides long service life and reduced maintenance
- Ideal for industrial and potable water applications
- Constructed of corrosion-resistant and FDA-compliant materials
- Low pressure drop and exceptional flow capacity
- No tools required for disassembly or cleaning

Dimensions and Weights

- Contact your Spraying Systems Co. sales engineer for dimensions and weights



Ordering Information

Complete Filtration Assembly

39185	—	3/4	—	SAN	—	130
Filter Type		Inlet Conn.		Material Code		Filter Size

Ordering Information

Permanent Filter Only

39187	—	130
Filter Type		Filter Size

See pages 13 for additional mesh data and ordering information.

Specifications

Inlet Connection	Materials	Connection Type NPT or BSPT (F)	Pressure Rating	Max. Temperature	Available Filter	Size of Filter Opening in. (mm)
3/4"	Clear Styrene Acrylonitrile, or Polypropylene	Threaded	125 psi @ 65° F (8.4 bar @ 18° C)	Element: 190° F (88° C)	80	.007" (.18)
				Housing: 120° F (50° C)	130	.005" (.13)
					300	.002" (.05)

Pressure Gauges

Features and Benefits

- Provides stable, accurate needle readings up to the rated maximum pressure
- Grade B accuracy within $\pm 2\%$ in the middle of the scale, and 3% accuracy in the high and low ends of the scale
- Patented spring suspended movement
- Corrosion- and impact-resistant ABS housing with polycarbonate window
- Dual scales in psi and bar

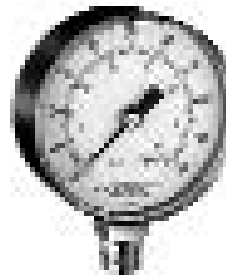

Model 26385
has a bottom connection

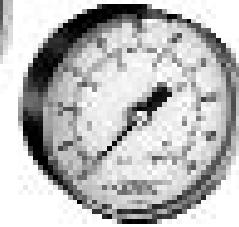

Model 26383
has a center back connection

Ordering Information

2 6 3 8 3	—	1 / 8 *	—	6 0
 Gauge Type		 Inlet Conn.		 Pressure Rating

*Specify Inlet Conn. for 26383 only

Specifications

Model	Inlet Connection NPT (M)	Materials	Pressure Rating	Optimum Operating Range
26383	1/8", 1/4"	Wetted parts are brass, brass/bronze connection and bourdon tube	0 - 60 psi (0 - 4 bar) 0 - 100 psi (0 - 7 bar) 0 - 160 psi (0 - 11 bar)	—
26385	1/4"	Wetted parts are brass, brass/bronze connection and bourdon tube	0 - 60 psi (0 - 4 bar) 0 - 100 psi (0 - 7 bar) 0 - 160 psi (0 - 11 bar) 0 - 300 psi (0 - 21 bar)	15 - 45 psi (1.4 - 2.8 bar) 25 - 75 psi (2.4 - 4.5 bar) 40 - 120 psi (3.8 - 7.2 bar) 75 - 225 psi (7 - 13.8 bar)

Model 39194 Gauge Snubber

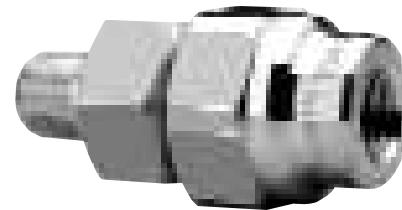

Features and Benefits

- Designed for use with air actuated spray guns, the gauge snubber dampens the pressure gauge action on a rapidly cycled air line
- Prolongs service life and improves readability of pressure gauges
- Easily disassembles for cleaning

Ordering Information

3 9 1 9 4	—	1 / 8 M	x	1 / 8 F
 Gauge Snubber No.		 Inlet Conn. Size		 Gauge Port Size

Specifications

Inlet Conn. NPT (M)	Gauge Port NPT (F)	Max Pressure	Body Material
1/8"	1/8"	300 psi (20 bar)	Brass with stainless steel orifice plate
1/4"	1/8", 1/4"		

Cleaning T Strainers

T strainers feature a removable bottom cap or plug for complete withdrawal of the screen assembly during cleaning. On some models, the bottom pipe plug can be replaced with a drain cock for quick-flush cleaning. Models with a clear nylon bowl allow easy visual inspection of the internal screen. Self-cleaning designs allow filtered liquid to pass through, while liquid particles are returned back to the liquid supply through a return outlet.

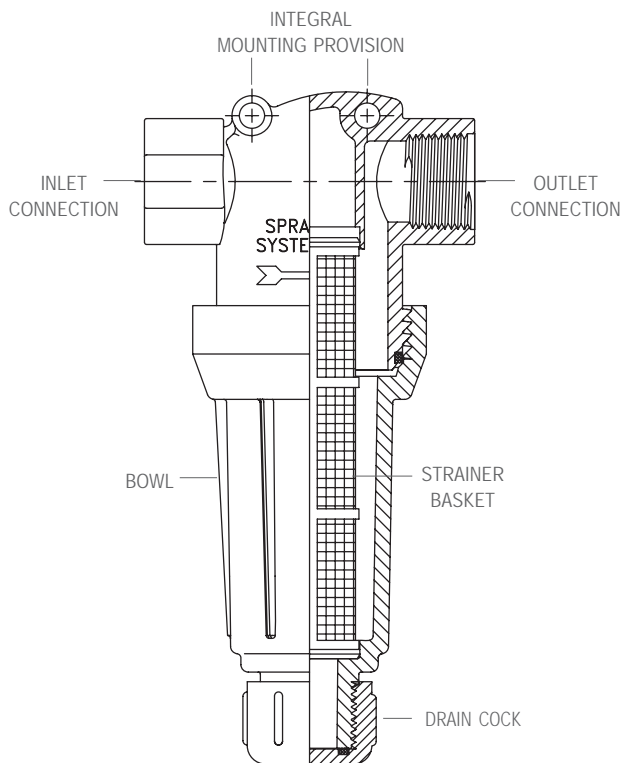

124A-SC
Self cleaning design for minimal maintenance

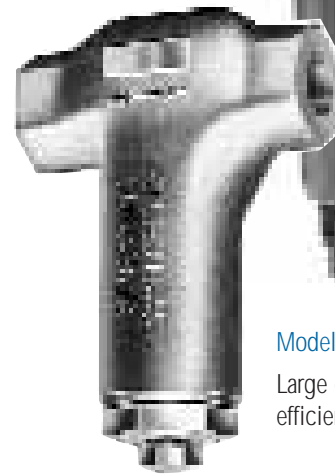

Model TW
Large open screen area for efficient liquid straining



430-ML
Features holes for mounting to machinery or an angle iron



122-NYC
Features clear nylon bowl

Calculating Pressure Drop

C_V (or K_V) is defined as the flow in gpm (m^3/h) through the strainer with a pressure drop of 1 psi (bar). Flow coefficient, commonly referred to as C_V (or K_V), is a measure of the resistance to flow. Once the factor is known, it is used in standardized equations to calculate flow rate or related parameters.

To determine pressure drop across the strainer at a specific flow rate:

Example:

50 gpm ($10 m^3/h$) water flow through an SSCO AA124-1-1/4 strainer

English (psi)	Metric (bar)
$^3P = (gpm/C_V)^2$	$^3P = (m^3/h/K_V)^2$
$^3P = (50/27.4)^2 = 3.3 \text{ psi}$	$^3P = (11.4/23.7)^2 = 0.23 \text{ bar}$

C_V (K_V) Values for Various Strainer Types

Pipe Conn. Size (NPT)	T Type			
	TW	TWC / TWF	124	430-ML & 430-SC
1/4"	1.9 (1.6)	—	—	—
3/8"	4 (3.5)	—	—	—
1/2"	5 (4.3)	—	—	—
3/4"	10 (8.7)	—	10 (8.7)	10.3 (8.82)
1"	14.3 (12.4)	—	15 (13)	15.65 (13.4)
1-1/4"	25.4 (22)	—	27.4 (23.7)	26.4 (22.9)
1-1/2"	31.6 (27.3)	—	32.7 (28.3)	34.4 (29.5)
2"	57.2 (49.5)	—	73 (63.1)	—
2-1/2"	70 (60.6)	80 (69.2)	80 (69.2)	—
3"	—	100 (86.5)	—	—
4"	—	219 (189)	—	—
6"	—	507 (439)	—	—
8"	—	—	—	—

Note: Given C_V (K_V) values are for water at 60° F (20° C) for clean mesh screen or perforated screen.

Selecting a Wire Mesh

For very fine straining applications, woven wire mesh screens provide much smaller openings down to 63 microns. The best wire mesh selection is a balance of open area, wire diameter and type of weave. Twenty mesh means 20 wires per inch in both a vertical and horizontal direction. Therefore, as wire size increases, the hole size decreases.

Mesh Liners

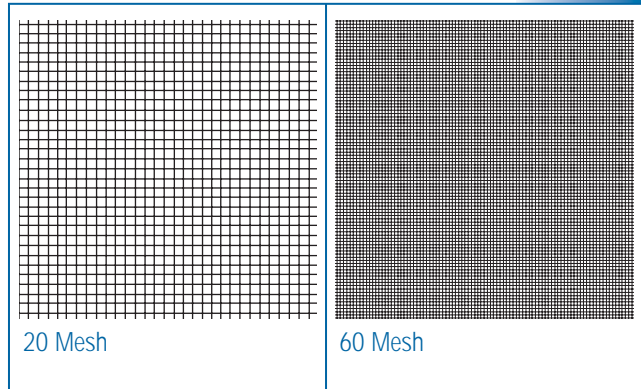

Mesh Basket Sheet Specifications

Mesh Size	Wire Dia. in. (mm)	Mesh Opening in. (mm)	Mesh Opening (microns)	Percentage Open Area
16	0.016" (.41)	0.045" (1.15)	1143	55.4
20	0.016" (.41)	0.0340" (.87)	864	46.2
30	0.012" (.31)	0.0213" (.55)	541	40.8
50	0.009" (.23)	0.0110" (.28)	279	30.3
60	0.0075" (.19)	0.0092" (.24)	234	30.5
80	0.0055" (.14)	0.0070" (.18)	177	31.4
100	0.0045" (.12)	0.0055" (.14)	140	30.3
200	0.0021" (.05)	0.0029" (.07)	74	33.6
40 x 200 Dutch Weave	0.007" x 0.005" (.18 x .13)	0.003" (.08)	63	—

Other Helpful Resources

We have an extensive library of bulletins and technical manuals available that may be of interest to you. Please call 1-800-95-SPRAY or visit www.spray.com to request additional literature.

Industrial Spray Products Catalog Catalog 70

Our full-product-line catalog is the industry's most comprehensive resource for spray nozzles and accessories. You'll find nozzle performance data, technical information and problem-solving ideas to help you optimize your spray application.



A Guide to Safe and Effective Tank Cleaning Catalog 15D

Technical paper provides useful guidelines on evaluating your plant's specific cleaning needs and selecting the most effective automated tank wash nozzle for your application.

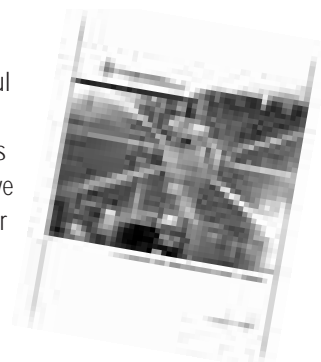

Spray Optimization Handbook Technical Manual 410

Explains how to maximize performance and quality in your spray application with nozzle maintenance and precision spray control.

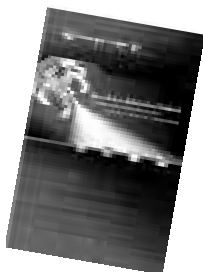

Spraying Systems Co.
Experts in Spray Technology

Spraying Systems Deutschland GmbH
Grossmoorkehre 1
D-21079 Hamburg
Tel: +49 (0)40 766 00 10
Fax: +49 (0)40 766 00 13 3
info@spray.de
www.spray.de

Spraying Systems Austria GmbH
Am Winterhafen 13
A-4020 Linz
Tel: +43 (0)70 77 65 40
Fax: +43 (0)70 77 65 40 10
info@spraying.at
www.spraying.at

SSCO-Spraying Systems AG
Eichenstrasse 6
CH-8808 Pfäffikon SZ
Tel: +41 (0)50 410 10 60
Fax: +41 (0)50 410 39 30
info.ch@spray.com
www.scco.ch



Spray
Nozzles



Spray
Control



Spray
Analysis



Spray
Fabrication

